

AAI[®]

AMERICAN ATHLETIC, INC.



FITNESS EQUIPMENT



G2N[™]

GYMNASTICS MEETS NINJA



800.247.3978 | AMERICANATHLETIC.COM

G2N™

GYMNASICS MEETS NINJA

- Strong enough for adults, adaptable enough for children, and unique enough for Ninjas
- Built of high quality steel providing strength and durability
- Powder coated for durable clean appearance
- Conveniently mounts to the wall and folds out in minutes
- Additional sections add challenges 10 square feet at a time
- Multiple attachments are easy to hang, adjust, or remove
- Rung pads included for safety

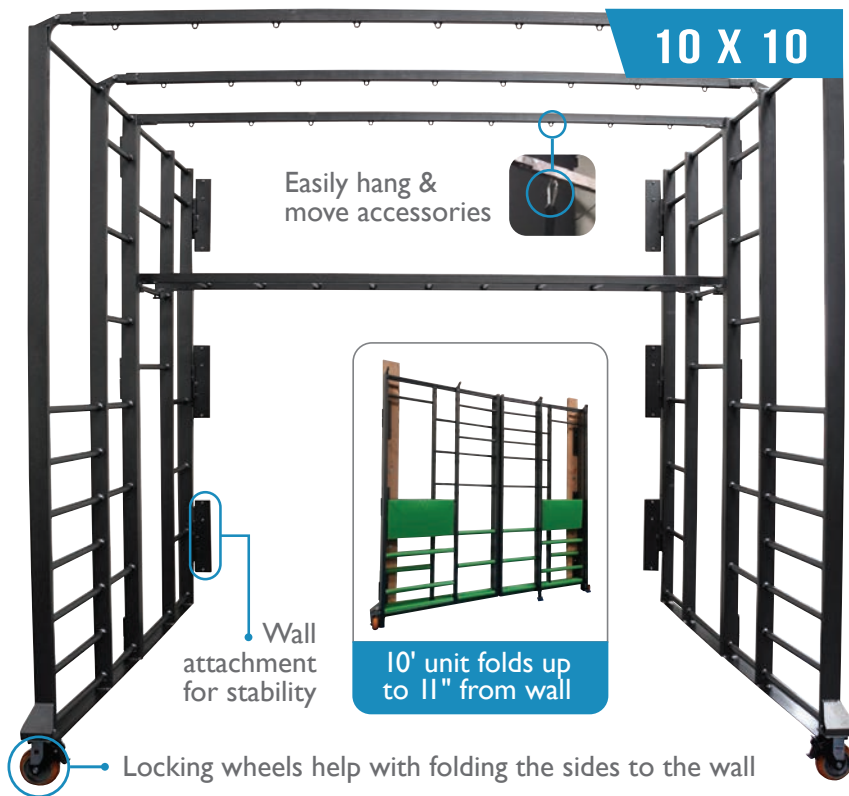

G2N™ CHALLENGES KIDS OF ALL AGES TO BE ACTIVE CREATIVE AND SKILLFUL. YOU CAN CALL IT WARRIOR, PARKOUR OR NINJA...WE CALL IT FUN!!

INDIVIDUAL (2 PIECE) UNITS OCCUPY 10' X 10' AREA WITH 12 DIFFERENT MOUNTING HEIGHTS FOR ATTACHMENTS



G2N™ GYMNASTICS MEETS NINJA

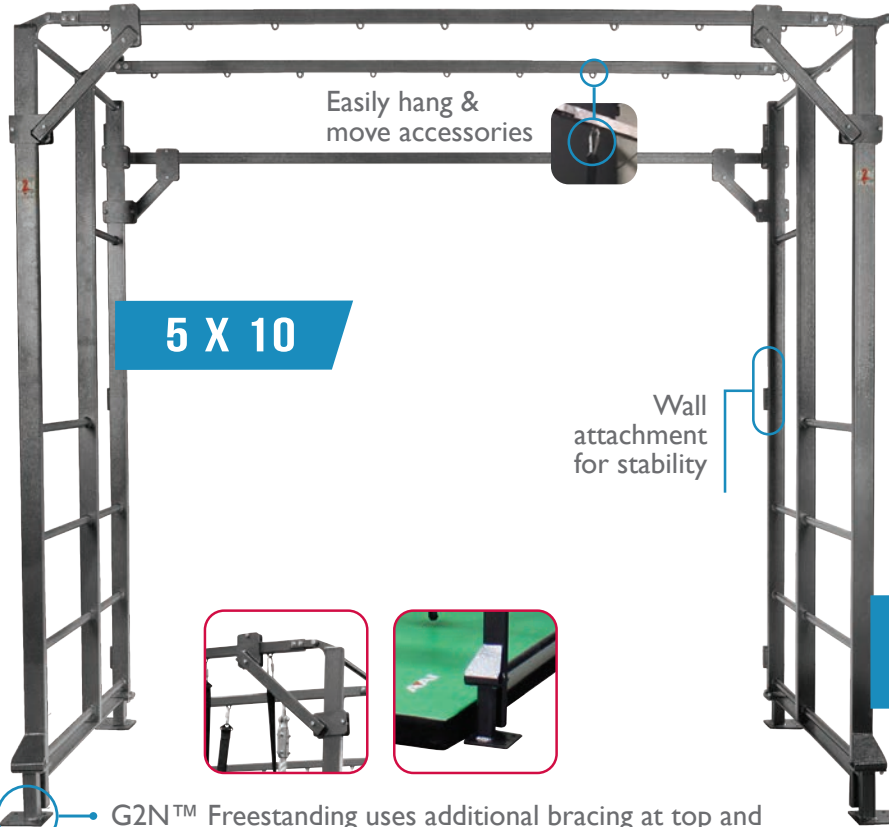

UNITS & PACKAGES AVAILABLE IN:

- 5X10
- 5X20
- 10X10
- 10X20

CONFIGURATIONS

AVAILABLE IN WALL-MOUNT OR FREESTANDING CONFIGURATIONS

NOW OFFERING 8 FT HIGH UNITS!



YOUR GYM DOESN'T NEED TO FIT G2N,
G2N FITS YOUR GYM

G2N™ ATTACHMENTS



BUILD YOUR OWN G2N™ PACKAGE

- STEP 1: CHOOSE THE UNIT HEIGHT - 8' OR 10'
- STEP 2: SELECT THE TYPE OF UNIT - WALL-MOUNT OR FREESTANDING
- STEP 3: CHOOSE THE UNIT LENGTH - 5' OR 10'
- STEP 4: SELECT YOUR ATTACHMENTS - ITEMS THAT HANG ON THE UNIT - PG 4-5
- STEP 5: PICK ADDITIONAL ACCESSORIES IF NEEDED - SOFT GOODS - PG 6
- STEP 6: DON'T FORGET THE MAT(S)!!
- STEP 7: WARP WALL...WHY NOT? MASTER OR WIZARD? FIND THEM ON PG 6
- STEP 8: COMBINE THE TOTAL OF ALL THE ABOVE COMPONENTS AND APPLY YOUR **DISCOUNT!***

*SEE OUR PRICE LIST FOR THE DISCOUNT VALUES.

SO MANY ATTACHMENTS AND ACCESSORIES TO MAKE G2N FIT YOUR GYM!

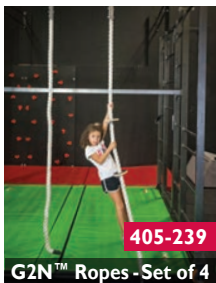
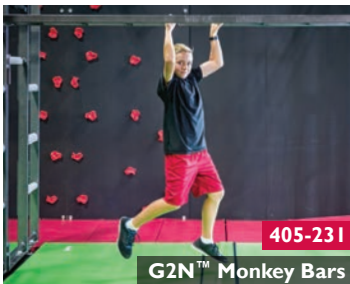

- Ropes
- Cargo Net
- Rings
- Monkey bars
- Floating Plank
- Ring Trainer
- Rockwall

And much more!

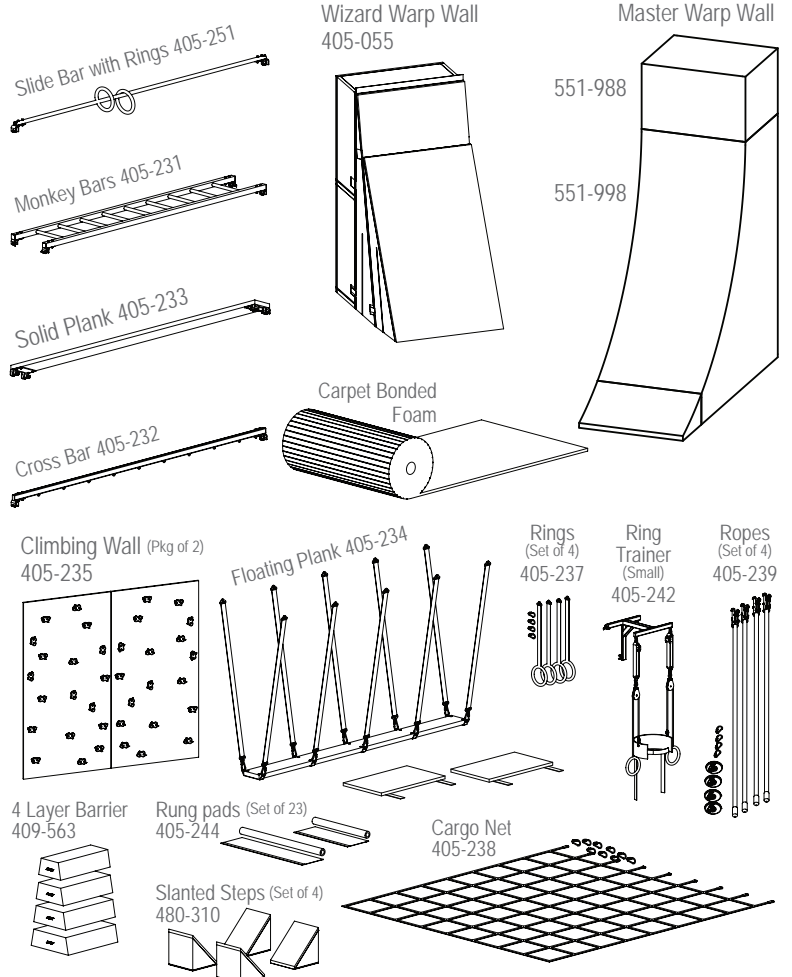

KEEP ADDING TO THE FUN!



NEW

3 RING STRAP

- Hang, Climb & Swing your way Up And down on the 3 ring strap
- Gain Strength and Body Awareness while you hang in the air reaching from ring to ring

405-275 3 Ring Strap



NEW

BOLSTER BAG

- The bolster bag provides a great deal of fun while your trying to jump onto it and catch it while it swings across the slide pole
- The padding provides the right amount of grip to allow you to hang onto the bag and maneuver off of it as you desire

405-290 Bolster Bag

NEW

FLOATING MONKEY BARS



- Floating monkey bars create endless angles of fun and challenges for all levels
- Use strap extensions to create a flat angle, or make it more challenging by turning it more vertical for the more advanced
- The angle of the ladder provides each athlete the challenge to make it constantly fun

405-292 Floating Monkey Bars



NEW

SWINGING PIPES

- The swinging pipes are fun for all ages
- Keep your set up nice and even, or mix up the straps to make it more difficult. Whatever you choose the swinging pipes will help all kids learn balance, strength and body awareness as they move through the different logs

405-294 Swinging Pipes

NEW

STEPPING SWING

- Use a double strap on each step side to reduce swing or a single strap on each side to increase swing between steps
- The stepping swing are fun for all ages

405-295 Stepping Swing - each

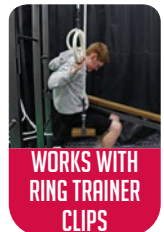
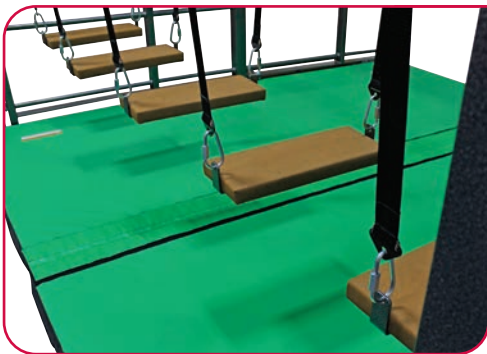

WORKS WITH RING TRAINER CLIPS

G2N™ OBSTACLES

- WITHOUT THE USE OF HOOK FASTENERS G2N™ OBSTACLES ARE EASIER AND FASTER TO MOVE AROUND WHEN CHANGING UP THE COURSE
- MADE WITH 18OZ VINYL AND POLYETHYLENE FOAM FOR DURABILITY AND EASY CLEANING
- ANTI-SKID MATERIAL KEEPS THE SHAPES FROM MOVING ON THE FLOOR OR WHEN STACKED

G2N™ WIZARD WARP WALL

405-055 G2N™ Wizard Warp Wall



G2N™ MASTER WARP WALL

551-998
G2N™ Master Top Block



551-988
G2N™ Master
Warp Wall

G2N™ OCTAROCK



480-315 G2N™
Large Octarock



480-314 G2N™
Medium Octarock



480-313 G2N™
Small Octarock

G2N™ BARRIER



- Available in 3 different configurations
- No attachments make the barrier easy to break down

409-572 G2N™ Barrier - 2 pieces
409-568 G2N™ Barrier - 3 pieces
409-563 G2N™ Barrier - 4 pieces

G2N™ BALANCE SERIES

Customize your own ninja courses with AAI®'s G2N™ package or individual pieces.

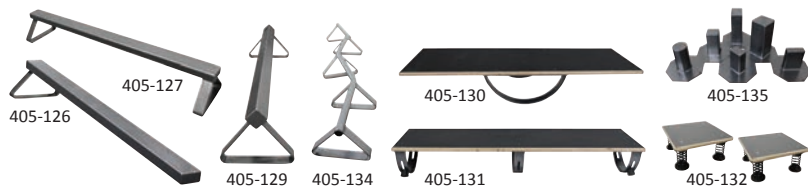

405-126 G2N™ Angled Beam
405-127 G2N™ Balance Beam
405-129 G2N™ Tipped Beam
405-130 G2N™ Rockertable
405-131 G2N™ Balance Board
405-132 G2N™ Quad Spring Board
405-134 G2N™ Snake Run
405-135 G2N™ Steel Stairs (Set of 6)

G2N™ SLANTED STEPS

- Buy individually or as a set of 4

480-309 G2N™ Slanted Steps - Each
480-310 G2N™ Slanted Steps - Set of 4





GYMNASTICS MEETS NINJA



G2N™ OFFERS A COMPREHENSIVE CURRICULUM THAT INCORPORATES FUNDAMENTAL GYMNASTICS CONCEPTS WITH PHYSICAL FITNESS COMPETENCIES.

The 8 week curriculum offers a turn key program to facilities. It comes with detailed weekly written lesson plans as well as training videos for the staff to ensure consistency within the program.

THE G2N™ CURRICULUM OFFERS FACILITIES:

- Turn key program for the staff
- An additional profit center
- A program that helps with member retention

THE G2N™ CURRICULUM TEACHES KIDS:

- STRENGTH
- ENDURANCE
- BALANCE
- FLEXIBILITY
- SKILL DEVELOPMENT
- FUN



8 FULL WEEKS!

VIDEOS

LESSON PLANS

SPOTTING CUES

SKILL DEVELOPMENT

SKILLS CARDS

COACH EVALUATION FORMS

PARENT REPORT CARDS

ACTIVE KIDS ARE BACK!

BARS



100 SERIES PARALLEL BARS

- Fiberglass composite bars are 1 9/16" (4cm) in diameter, 8' (2.4m) in length and adjust in width to 14", 16", and 18" (35, 40, and 45cm)
- Height adjusts from 45" to 77" (113 to 193cm)
- The height of the bars is adjusted using spin lock

405-116 100 Series Parallel Bars



LOW PARALLEL BARS

- Height from the floor is 16" (40cm)
- Fiberglass composite bars are 1 9/16" (4cm) in diameter, 8' (2.4m) in length and adjusts in width from 14" to 20" (35 to 50cm)

407-001 Low Parallel Bars



ALPHA ROCKER

- Great tool for training handstand skills and strength that transfer not only to Rings but also Parallel Bars, and Beam
- Rocking motion helps focus on stabilizer muscles
- Portable and easy to move

407-048 Alpha Rocker

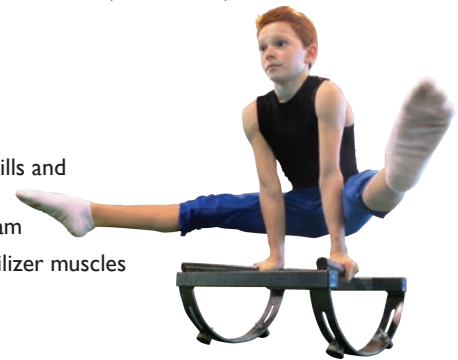

ROUND PARALLETTE BARS

- Made of solid maple and bar is covered in a protective laminate coating
- Bar is 12" in length (30cm)
- Overall dimensions of 13 1/2" long x 4 1/2" tall x 8" wide (34 x 11 x 20cm)

405-220 Round Parallette Bars — Pair

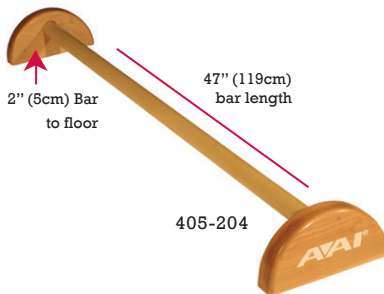

FLOOR TRAINING RAILS

- 405-204 wood end brace is 2" (5cm) wide x 9" long x 4 1/2" (11cm) high. Bar length of 47" (119cm)

405-204 2" Floor Training Rail



PRESCHOOL TRAINING BAR

- Combo spin/snap lock allows for easy adjustment
- Four height settings ranging from 34" to 52" (86 to 132cm)
- Base covers an area of 52" (132cm) wide x 46 1/2" (118cm) deep
- Any 4' (122cm) wide mat can be used between uprights
- Suggested ages/weight: 2-7 years & limit is 50-75 lbs.

G407-668 Preschool Training Bar (Steel Bar)

G407-684 Preschool Training Bar (Laminate Bar)

CHALK

CHALK

2 ounce blocks of magnesium carbonate gym chalk, perfect for gymnastics, weight training, and more!

407-550 1 lb Chalk in 2 oz blocks

407-565 36 lb Chalk in 2 oz blocks



EVO-BLACK CHALK HOLDER

- Chalk bowl made of rugged white polyethylene top and a black polyethylene bottom
- Stands 32" (81 cm) tall

407-197 Evo Chalk Holder



LOW CHALK HOLDER

- Made of rugged white polyethylene
- 13" (33cm) wide base for stability
- Stands 20" (50cm) tall

407-011 Low Chalk Holder



STEP-IN CHALK HOLDER

- Step-in chalk bowl made of rugged white polyethylene
- Place on floor for easy access
- 24" (61cm) in diameter x 2" (5cm) high

407-007 Step-In Chalk Holder



HIGH CHALK HOLDER

- Chalk bowl made of rugged white polyethylene
- Stands 32" (81cm) tall

407-008 High Chalk Holder



TRUCE CLEANERS

- SLS-free (No Sulfates)
- No Phthalates, Phosphates, and Parabens
- No Dyes and Fragrance-free
- Toxin-free and cruelty-free
- Hypoallergenic and Aromatherapeutic

60099 Chalk Remover - Gallon

60098 Chalk Remover - Case of 4

60097 All-Purpose Cleaner - Gallon

60096 All-Purpose Cleaner - Case of 4





truce
GREAT FOR USE ON VINYL & SUEDE PRODUCTS!



MATTING

FOLDING MAT ORDER GUIDELINES

When ordering folding mats, please follow the simple four steps below.

Mat Style	Foam Filler	Panel Width	Folding Interval
EM 1.4-2	 1 3/8" cross-link polyethylene	2'	2'
IM 1.5	 1 1/2" laminated polyethylene	2'	2'



4 x 8 Rainbow Mat

1. CHOOSE FOAM

- EM or IM Series

2. CHOOSE SIZE

Mat sizes for EM series

- 4' x 6' (1.2 x 1.8m)
- 4' x 8' (1.2 x 2.4m)
- 5' x 10' (1.5 x 3.0m)
- 6' x 12' (1.8 x 3.6m)

Mat sizes for IM series

- 4' x 6' (1.2 x 1.8m)
- 4' x 8' (1.2 x 2.4m)
- 4' x 10' (1.2 x 3.0m)
- 4' x 12' (1.2 x 3.6m)
- 5' x 10' (1.5 x 3.0m)
- 6' x 12' (1.8 x 3.6m)

3. CHOOSE FASTENER

- V0, V2 and V4
(placed on the ends of V2 mats)

4. CHOOSE COLOR

- See color charts at the side to select color options
- Rainbow mats come in repeating panels of royal blue, red, green and yellow
- Custom multi-colors available — see color guides below

18 OZ. VINYL COLORS

Note: Colors shown in catalog and on website may not be an exact match. Please request a color swatch.



HANDSTAND PUSH-UP MAT

- 2' X 3' working surface matches the specifications for Competition
- Soft enough to protect your head, but firm enough to give stability
- Anti-skid bottom helps prevent movement

470-155 Handstand Push-up Mat

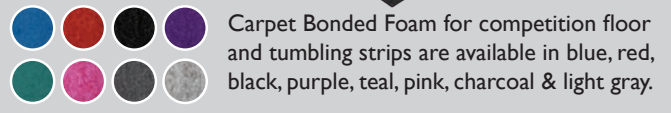

Carpet Bonded Foam for competition floor and tumbling strips are available in blue, red, black, purple, teal, pink, charcoal & light gray.

ENVIROLITE™ CBF - FLEX ROLL

416-786 Carpet Bonded Foam - Flex Roll - 6' x 42' x 1-3/8"
(Blue, Black, Light Gray, Red or Charcoal)

416-787 Carpet Bonded Foam - Flex Roll - 6' x 42' x 2"
(Blue, Black, Light Gray, Red or Charcoal)

416-820 Carpet Bonded Foam - EVA - Flex Roll - 6' x 42' x 1-1/2"
(Blue, Black, Light Gray, Red or Charcoal)

416-822 Carpet Bonded Foam - EVA - Flex Roll - 6' x 42' x 2"
(Blue, Black, Light Gray, Red or Charcoal)

INCLINES

INCLINES

AAI's most popular motor development shape!
A must for teaching rolls and other basic skills.

- Folding inclines double as spotting blocks
- Inclines available with firm top layer which provides extra stiffness for handsprings or soft top layer for more cushion
- Inclines are available in different configurations*;
 - Standard Foam or Firm Foam
 - Folding or Non-Folding
 - Multiples Sizes
 - 24"x48"x14"
 - 36"x72"x16"
 - 48"x72"x16"
 - 60"x84"x18"
 - 48"x96"x24"
 - 60"x120"x24"

*See our price list for more details.

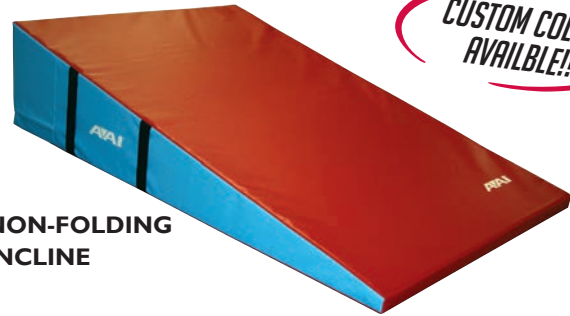

NON-FOLDING INCLINE

CUSTOM COLORS AVAILABLE!!



FOLDING INCLINE

MATCH YOUR TEAM COLORS!

AAI can customize mats and skill shapes of 18oz vinyl with your team colors. Pick from our 15 vinyl color options at no extra charge.



MAKE IT STAND OUT!

AAI can screen your gym's logo onto the mats and skill shapes.

ARTWORK REQUIREMENTS
File Type: .AI, .EPS or .PDF



GYM DESIGN

AAI can help design a gym whether you're starting from scratch or remodeling a gym.

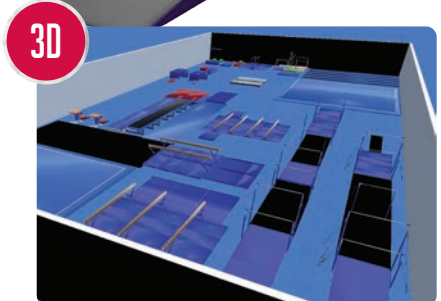
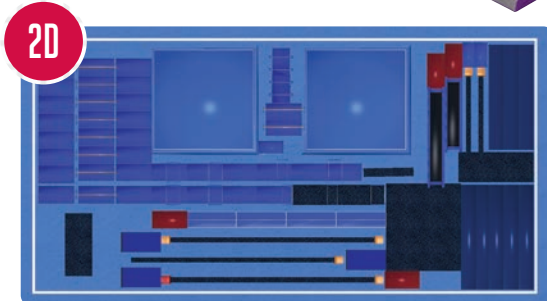

DEVELOPMENTAL ACCESSORIES



OCTAGONS

- Fasteners connect shapes in a row for a variety of activities

480-288 Octagon 20" x 28" (51 x 71cm) – Lime/Marine Blue

480-289 Octagon 25" x 36" (63 x 91cm) – Purple/Pink

480-290 Octagon 30" x 36" (78 x 91cm) – Red/Green

480-307 Octagon 35" x 40" (89 x 102cm) – Marine Blue/Yellow



TRAPEZOIDS

480-056 Trapezoid 48" x 48" x 36" (122 x 122 x 92cm) – Royal Blue

480-303 Rainbow Trapezoid 48" x 48" x 36" (122 x 122 x 92cm) – Yellow/Red/Lime/Purple (top to bottom)

480-304 Small Rainbow Trapezoid 36" x 36" x 30" (92 x 92 x 76cm) – Yellow/Red/Purple (top to bottom)

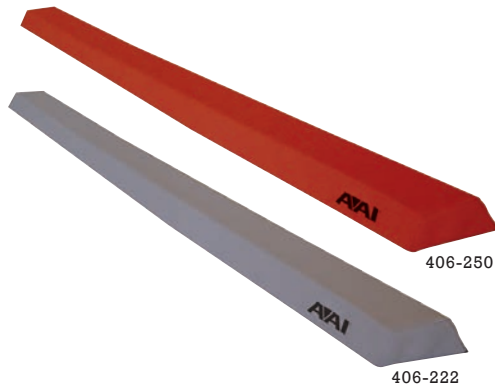

TAC/10 & FOAM BALANCE BEAM

- 406-250 TAC/10 cover provides easy cleaning with excellent grip and durability
- 406-222 Durable suede cover provides authentic balance beam feel
- 4" (10cm) beam width provides the gymnast with a comfortable working surface
- Foam core is constructed using polyethylene foam

406-250 TAC/10 Foam Balance Beam 4" x 106" x 2" (10 x 269 x 5cm)

406-222 Foam Balance Beam 4" x 106" x 2" (10 x 269 x 5cm)



JUNIOR BALANCE BEAMS

- Wood core construction
- Top of beam is 5 1/2" (14cm) high
- Beam rests on wooden feet
- Beam width is 4" (10cm)

406-223 Junior Balance Beam 8' (2.4m)

406-224 Junior Balance Beam 10' (3m)

DEVELOPMENTAL ACCESSORIES

PREMIER VAULT TRAMPOLINE

- Adjustable rear legs to three different heights: 13", 14" and 15" (33cm, 36cm & 38cm)
- Front adjusts to lower the bed to sit on the floor
- Frame pads included

405-115 Premier Vault Trampoline

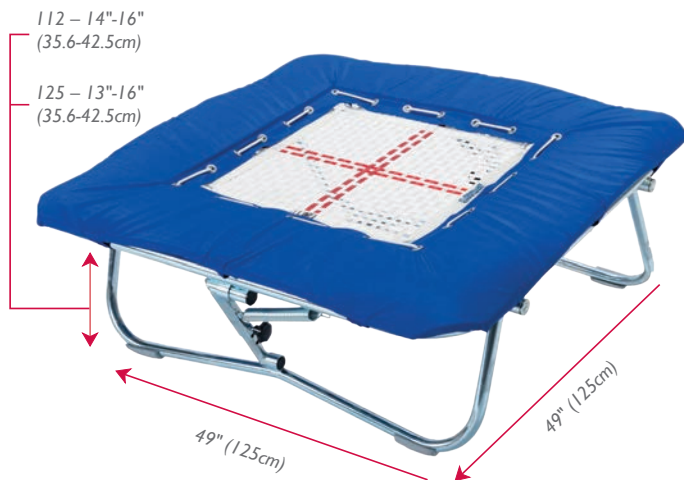
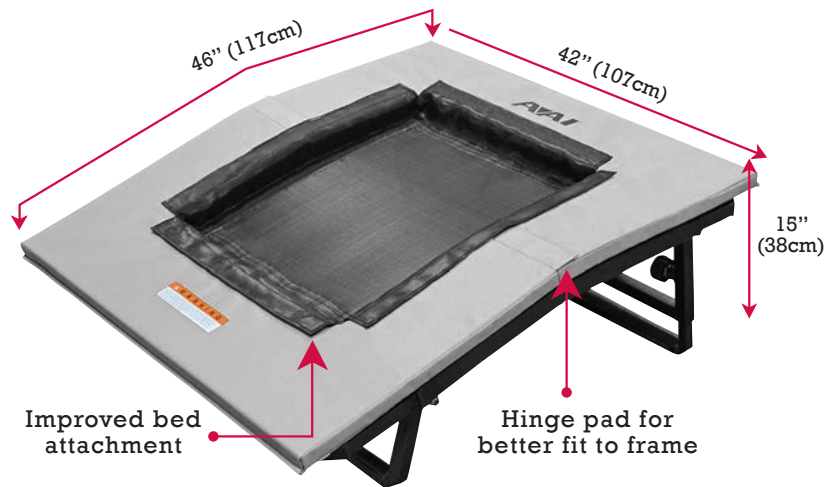

MINITRAMP 112 & 125

- Used as an angled take-off trampoline and can be used for vaulting
- There are a variety of uses in schools or in rehabilitation centers
- A jumping bed provides the necessary performance level for all athletes
- Difference between 112 & 125 is dimensional (112cm sq. vs 125cm sq.)
- Shock absorbing and stable frame pads
- Wheels for easy transport & adjustable in height

403-112 Minitramp 112

403-118 Minitramp 125

SPOTTING BLOCK

- High density foam filler, with top and bottom layers of firm polyethylene foam add support for the instructor
- Firm inner core for added stability

416-048 Spotting Block 2' x 2' x 4' (61 x 61 x 122cm)

416-042 Spotting Block 2' x 1' x 4' (61 x 30 x 122cm)

416-169 Spotting Block 30" x 30" x 30" (76 x 76 x 76 cm) – Marine/Royal



GAGA/FACILITY

GAGA IS A GREAT GAME TO ADD FOR BIRTHDAY PARTIES AT THE GYM CLUB!



WIDE & SHORT HURDLES FOR NINJA COURSES

GAGA IS A CO-ED SPORT THAT CAN BE PLAYED BY ALL AGES. A DIFFERENT WAY TO GET UP AND MOVING. AAI® GAGA PIT IS FOR INDOOR USE AT GYM CLUBS, SCHOOLS AND REC CENTERS.

- Gaga is similar to dodge ball but played with a single ball. The game consists of dodging, running, jumping or striking the ball with the goal to be last person in the Gaga pit. Players hit the ball at each other using their hands, being eliminated if the ball strikes them on or below the knee. Gaga can be played by several individual players or in teams.

480-572 8' x 30" Gaga Wall **480-574** 12' Complete Gaga Pit
480-573 3' x 24" Gaga Wall **480-575** 14' Complete Gaga Pit

Custom colors available contact AAI at 1-800-247-3978



PLAY INDOORS



EASY TAKE APART



480-574

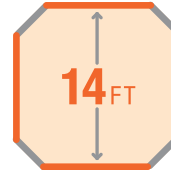

480-575

Customize your Gaga Pit size by adding additional sides to expand game area for larger groups.

BASKETBALL | GYMNASIUM | VOLLEYBALL

ALSO AVAILABLE FROM OUR FACILITY

- › BASKETBALL GOAL & BACKBOARDS
- › VOLLEYBALL UPRIGHTS & NETS
- › WALL PADDING & DIVIDER CURTAINS
- › RETRACTABLE EQUIPMENT



800-435-3865

SPALDINGEQUIPMENT.COM

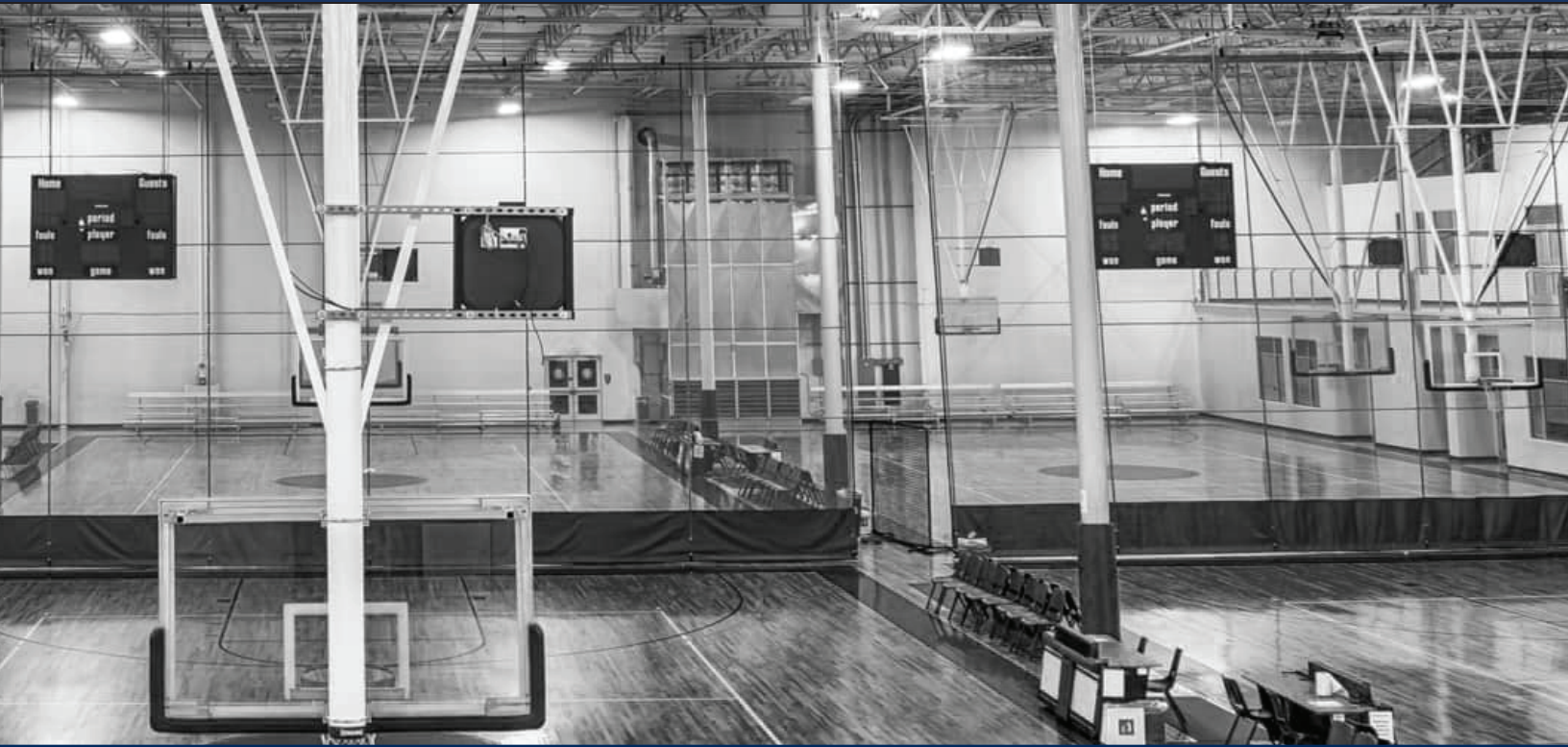

SAFETY

AT SPALDING, YOUR GYM'S SAFETY IS OUR TOP PRIORITY!

We engineer all Spalding ceiling-suspended units with high quality hardware, customizable powder coated parts, safety cables, and even include back-up systems like the Auto-O-Loc 2 safety strap on all Spalding mechanized ceiling-suspended backstops.

Our gym construction and renovation team will work with your facility crew to assess your needs, specify the right equipment and provide a quality and safe installation.

It doesn't matter if you are working on a new gym or are making updates to your existing wall or ceiling-suspended systems, divider curtains, wall padding, volleyball equipment or other gym equipment, Spalding can help. Our certified installers are available and offer full-service work to complete your project.

For all your gymnasium needs, contact Spalding at
800-435-3865 | INQUIRE@SPALDINGEQUIPMENT.COM.

You can also find all certified Spalding GymPro dealers on our website at
WWW.SPALDINGEQUIPMENT.COM.

WALL PADDING

SHARED FEATURES:

- STANDARD WALL PAD SIZE IS 2' X 6'
- CHOOSE FROM A VARIETY OF STANDARD COLORS

- PAD MEETS NATIONAL FIRE PROTECTION STANDARD 701, ASTM E-84 AND CAL 117
- 2 7/16" (62MM) THICK PROTECTIVE WALL PADDING CAN BE INSTALLED PERMANENTLY OR REMOVABLE



O.S.B. Backing

Polychloroprene foam

Vinyl cover

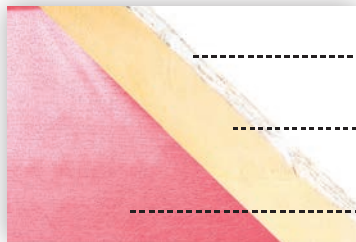

O.S.B. Backing

100 ILD Polyurethane foam

Vinyl cover



O.S.B. Backing

Laminated Polyurethane foam

Vinyl cover

CLASS A FIRE WALL PADS

- Constructed of 7/16" (11mm) O.S.B. backing, 2" polychloroprene foam and 18 oz. vinyl cover
- Class A Fire Rating (meets ASTM E84 testing procedures)

2" POLYURETHANE WALL PADS

- Constructed of 7/16" (11mm) O.S.B. backing, 2" 100 ILD polyurethane foam and 18 oz. vinyl cover

2" LAMINATE WALL PADS

- Constructed of 7/16" (11mm) O.S.B. backing, 2" laminated polyethylene foam and 18 oz. vinyl cover



BATTING CAGES



↑
CAGE EASILY RAISES
AND LOWERS FROM THE
CEILING
↓

BATTING CAGES

- Designed for indoor use only
- Frame is constructed of zinc-coated piping
- Minimum ceiling height requirement of 17'
- Cast fittings connect perimeter
- 1 hp electric motor
- Netting attaches easily to the frame with hook and loop straps
- Black net is made of a high strength polyethylene material
- Standard mesh size is 1 3/4" with 3/4" mesh available for golf

-
- 417-278** Motorized Retractable 70' Cage (net not included)
 - 417-279** Motorized Retractable 55' Cage (net not included)
 - 417-386** 14' wide x 70' long Batting Cage Net Package
 - 417-387** 12' wide x 70' long Batting Cage Net Package
 - 417-388** 14' wide x 55' long Batting Cage Net Package
 - 417-389** 12' wide x 55' long Batting Cage Net Package
 - 417-395** 14' wide x 70' long Golf Mesh Cage Net Package

THE BEAST PORTABLE SYSTEM

THE BEAST[®]



THE BEAST 60 GLASS PORTABLE

- Designed for side court recreational or outdoor residential play
- Board size: 60" x 36"
- Tempered glass board
- Steel board frame
- Steel Pro Image™ breakaway rim
- 7.5' to 10' height adjustment; screw jack lift
- 5" square steel pole
- Power Move™ Base fills with 55 gallons of water or sand
- Four wheels
- 5-Year Limited Warranty

421-232 The Beast 60 Glass Portable

BALL CARTS

NBA® BALL TRUCK

- Holds 18 full size basketballs
- Constructed of steel tubing with grey powder-coat finish
- Includes swivel wheels
- Non-topple base
- Angled rails for easy ball removal

411-603 NBA® Ball Truck



REPLICA BALL TRUCK

- Holds 15 full size basketballs
- Constructed of durable chrome steel tubing
- Swivel casters
- Non-topple base
- Angled rails for easy ball removal

411-602 Replica Ball Truck



ECONOMY BALL TRUCK

- Constructed of durable chrome steel tubing
- Swivel casters
- Non-topple base
- Holds up to 12 balls

411-600 Economy Ball Truck



BALL LOCKER

- Constructed of welded steel
- Non-marring swivel casters
- Lockable
- Holds up to 30 basketballs or 36 volleyballs

411-605 Ball Locker



SPALDING® VOLLEYCADDY

- Innovative cart and carry system
- Kit includes nylon bag with carry strap
- Holds up to 8 volleyballs

438-070 Spalding® VolleyCaddy - Black



- > **COMPETITION EQUIPMENT**
- > **TRAINING EQUIPMENT**
- > **NINJA COURSES**
- > **MOTOR DEVELOPMENT**

AAI®

SPALDING
TRUE TO THE GAME®

- > **BASKETBALL GOAL & BACKBOARDS**
- > **VOLLEYBALL UPRIGHTS & NETS**
- > **WALL PADDING & DIVIDER CURTAINS**
- > **RETRACTABLE EQUIPMENT**

**GENERAL WARRANTY INFORMATION AVAILABLE AT
SPALDINGEQUIPMENT.COM/WARRANTY**

CALIFORNIA PROPOSITION 65

Certain products in this catalog are subject to the California Safe Drinking Water and Toxic Enforcement Act of 1986, more commonly known as "Proposition 65." Proposition 65 requires clear and reasonable warnings for products that expose individuals in the State of California to a chemical known to the State to cause cancer, birth defects, and other reproductive harm. Applicable products shipped to California will have the following Warning (or other appropriate warning) affixed:

WARNING: This product contains chemicals known to the State of California to cause cancer, birth defects and other reproductive harm.

WARRANTY DETAILS

AAI warrants its products against defects in material and workmanship. Without charge, AAI will, at its option, either repair or replace any products shown to our satisfaction to be defective within one (1) year from receipt by customer, provided it is returned to the factory (after authorization), transportation prepaid. This warranty covers only products manufactured by AAI and does not extend to transportation, installation or replacement charges incurred by customer; nor does it apply to products or components of another manufacturer appearing in this catalog or used in conjunction with AAI products according to the terms here of and standards acceptable in AAI's industry.

This warranty is exclusive and in lieu of any other express or implied warranties, including but not limited to any implied warranty of merchantability or fitness for particular purpose.

Modification of AAI products renders the warranty void and could create a risk of severe personal injury. Abuse, misuse, abnormal usage, faulty installation, improper maintenance or unauthorized repairs are not covered under warranty. No obligations or liabilities exist on the part of AAI for consequential damages arising out of or in connection with the use or performance of the products.